



■ Features :

- Universal AC input / Full range
- Built in active PFC circuit compliance to EN61000-3-2
- Protections: Short circuit / Overload / Over voltage / Over temperature
- Free air convection for 400W and 500W with 23.5CFM forced air
- High power density 6.2w/in³
- AC input active surge current limiting
- U-bracket low profile:41mm
- Built-in remote ON-OFF control
- Built-in remote sense function
- Built in DC OK active signal
- 3 years warranty



SPECIFICATION

MODEL	USP-500-5	USP-500-12	USP-500-15	USP-500-24	USP-500-48	
OUTPUT	DC VOLTAGE	5V	12V	15V	24V	48V
	RATED CURRENT	80A	42A	33.5A	21A	10.5A
	CURRENT RANGE (convection)	0 ~ 60A	0 ~ 33A	0 ~ 27A	0 ~ 17A	0 ~ 8.5A
	CURRENT RANGE (23.5CFM FAN)	0 ~ 80A	0 ~ 42A	0 ~ 33.5A	0 ~ 21A	0 ~ 10.5A
	RATED POWER (convection)	300W	396W	405W	408W	408W
	RATED POWER (23.5CFM FAN)	400W	504W	502.5W	504W	504W
	RIPPLE & NOISE (max.) Note.2	80mVp-p	100mVp-p	100mVp-p	150mVp-p	150mVp-p
	VOLTAGE ADJ. RANGE	4.5 ~ 5.5V	10.8 ~ 13.2V	13.5 ~ 16.5V	21.6 ~ 27V	43.2 ~ 52.8V
	VOLTAGE TOLERANCE Note.3	±2.0%	±2.0%	±2.0%	±2.0%	±2.0%
	LINE REGULATION	±0.5%	±0.5%	±0.5%	±0.5%	±0.5%
	LOAD REGULATION	±2.0%	±1.0%	±1.0%	±1.0%	±1.0%
	SETUP, RISE TIME	1500ms, 60ms/230VAC 3100ms, 60ms/115VAC at full load				
HOLD UP TIME (Typ.)	16ms/230VAC 16ms/115VAC at full load					
INPUT	VOLTAGE RANGE Note.5	90 ~ 264VAC	127 ~ 370VDC			
	FREQUENCY RANGE	47 ~ 63Hz				
	POWER FACTOR (Typ.)	0.95/230VAC	0.98/115VAC at full load			
	EFFICIENCY (Typ.)	85%	90%	90%	89%	90%
	AC CURRENT (Typ.)	6A/115VAC	2.6A/230VAC			
	INRUSH CURRENT (Typ.)	30A/115VAC	50A/230VAC			
LEAKAGE CURRENT	<2mA / 240VAC					
PROTECTION	OVERLOAD	105 ~ 130% rated output power Protection type : Constant current limiting, unit will shut down after 3 sec. re-power on to recover				
	OVER VOLTAGE	5.7 ~ 7V	13.5 ~ 16V	17 ~ 21V	27.8 ~ 32.4V	53 ~ 64.8V
	OVER TEMPERATURE	85°C±5°C (TSW1 : detect on heatsink of o/p diode) 95°C±5°C (5V), 100°C (12V, 15V, 24V, 48V) (TSW2 : detect on heatsink of power transistor) Protection type : Shut down o/p voltage with auto-recovery				
FUNCTION	REMOTE ON/OFF CONTROL	RC+/RC-: 0~0.8V power on ; 4~10V power off				
	DC-OK SIGNAL	PSU turn on : 3.3V ~ 5.6V ; PSU turn off: 0 ~ 1V				
ENVIRONMENT	WORKING TEMP.	-20 ~ +60°C (Refer to output load derating curve)				
	WORKING HUMIDITY	20 ~ 90% RH non-condensing				
	STORAGE TEMP., HUMIDITY	-40 ~ +85°C, 10 ~ 95% RH				
	TEMP. COEFFICIENT	±0.03%/°C (0 ~ 50°C)				
	VIBRATION	10 ~ 500Hz, 2G 10min./1cycle, 60min. each along X, Y, Z axes				
SAFETY & EMC (Note 4)	SAFETY STANDARDS	UL60950-1, TUV EN60950-1 approved				
	WITHSTAND VOLTAGE	I/P-O/P:3KVAC I/P-FG:1.5KVAC O/P-FG:0.5KVAC				
	ISOLATION RESISTANCE	I/P-O/P, I/P-FG, O/P-FG:100M Ohms/500VDC 25°C 70%RH				
	EMI CONDUCTION & RADIATION	Compliance to EN55022 (CISPR22) Class B				
	HARMONIC CURRENT	Compliance to EN61000-3-2,-3				
EMS IMMUNITY	Compliance to EN61000-4-2,3,4,5,6,8,11, ENV50204, EN55024, EN61000-6-2, heavy industry level, criteria A					
OTHERS	MTBF	129.8K hrs min. MIL-HDBK-217F (25°C)				
	DIMENSION	254*127*41mm (L*W*H)				
	PACKING	1.6Kg; 6pcs/10.6Kg/0.67CUFT				
NOTE	<p>1. All parameters NOT specially mentioned are measured at 230VAC input, rated load and 25°C of ambient temperature.</p> <p>2. Ripple & noise are measured at 20MHz of bandwidth by using a 12" twisted pair-wire terminated with a 0.1uf & 47uf parallel capacitor.</p> <p>3. Tolerance : includes set up tolerance, line regulation and load regulation.</p> <p>4. The power supply is considered a component which will be installed into a final equipment. The final equipment must be re-confirmed that it still meets EMC directives.</p> <p>5. Derating may be needed under low input voltages. Please check the derating curve for more details.</p>					

Mechanical Specification

Case No. 963A-D Unit:mm

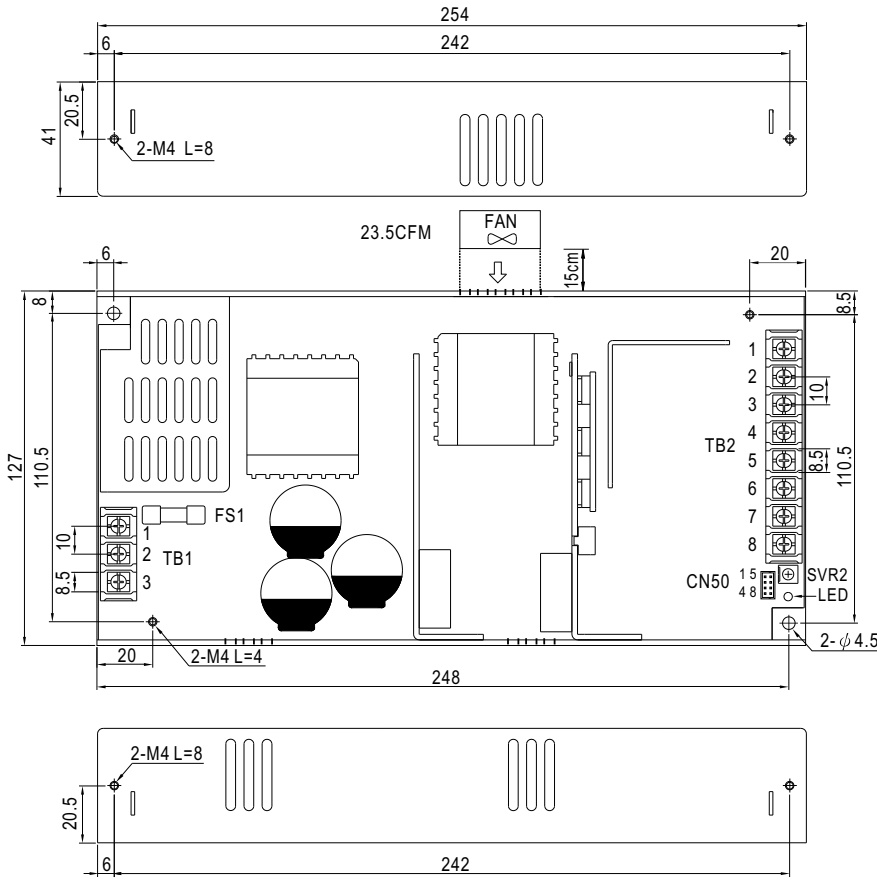

AC Input Terminal Pin. No. Assignment

Pin No.	Assignment
1	AC/L
2	AC/N
3	FG \perp

DC Output Terminal Pin. No. Assignment

Pin No.	Assignment
1~4	DC OUTPUT -V
5~8	DC OUTPUT +V

Connector pin number assignment (CN50) : JST B8B-PHDSS or equivalent

Pin No.	Assignment	Mating Housing	Terminal
1	+S	JST PHD-08VS or equivalent	JST SPHD-002T-P0.5 or equivalent
2	DC- OK GND		
3	RC-		
4	NC		
5	-S		
6	DC-OK		
7	RC+		
8	-S		

Block Diagram

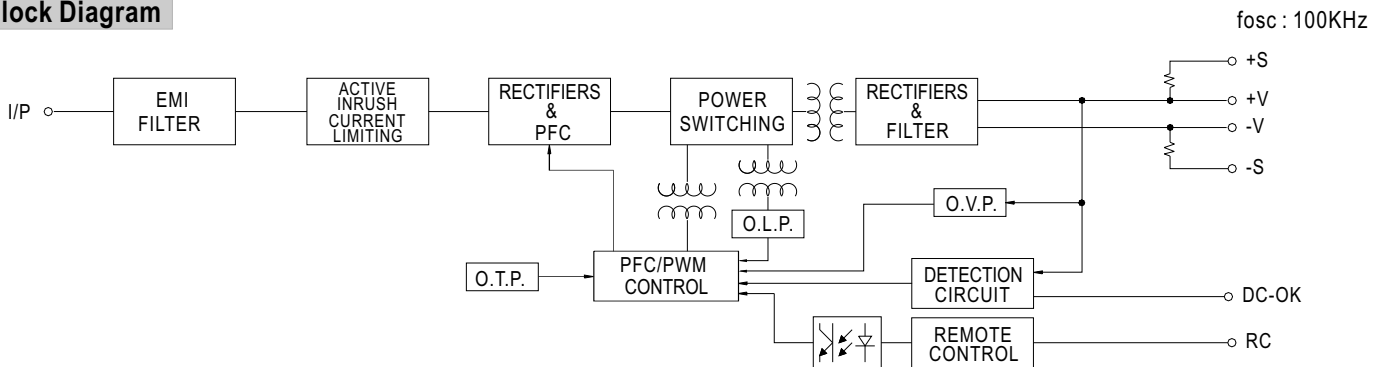

Derating Curve

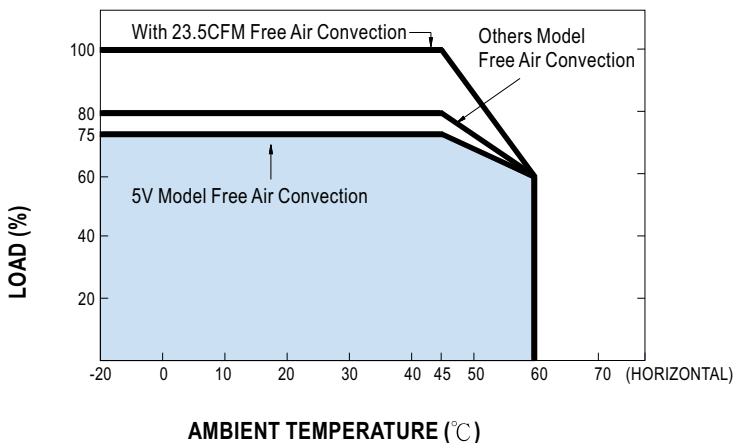

Static Characteristics

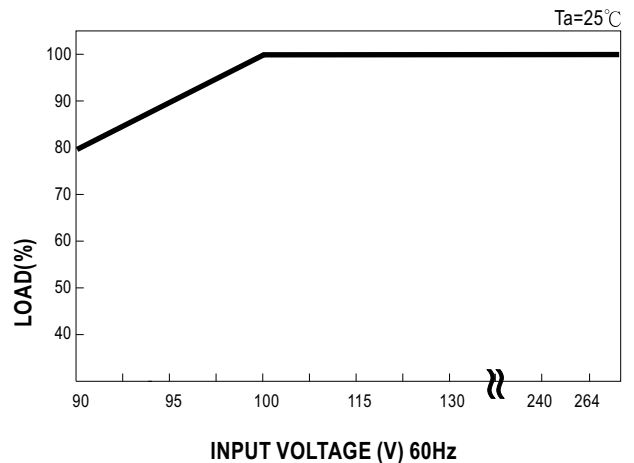

■ Function Description of CN50

Pin No.	Function	Description
1	+S	Positive sensing. The +S signal should be connected to the positive terminal of the load. The +S and -S leads should be twisted in pair to minimize noise pick-up effect. The maximum line drop compensation is 0.5V.
2	DC-OK GND	This pin connects to the negative terminal (-V). Return for DC_OK Signal output.
3	RC-	Return for RC+ signal input.
5,8	-S	Negative sensing. The -S signal should be connected to the negative terminal of the load. The -S and +S leads should be twisted in pair to minimize noise pick-up effect. The maximum line drop compensation is 0.5V.
6	DC-OK	DC-OK Signal is a TTL level signal, referenced to pin3(DC-OK GND). High when PSU turns on.
7	RC+	Turns the output on and off by electrical or dry contact between pin 7 (RC+) and pin 3 (RC-). 0~0.8V: Power ON, 4~10V: Power OFF.

■ Function Manual

1.Remote Control

The PSU can be turned ON/OFF by using the "Remote Control" function.

Between RC+(pin7) and RC-(pin3)	Output Status
SW OFF (0 ~ 0.8V)	ON
SW ON (4 ~ 10V)	OFF

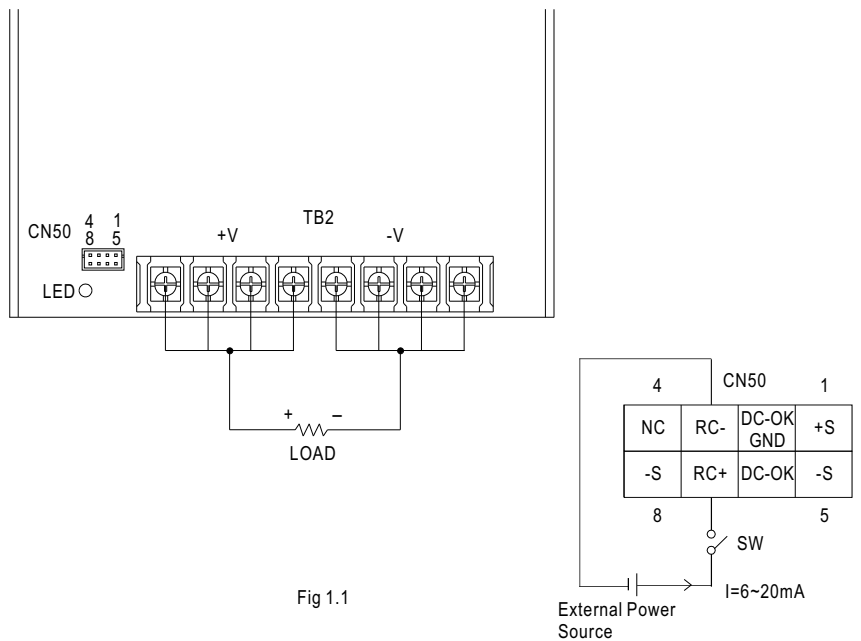

Fig 1.1

2.DC-OK Signal

DC-OK Signal is a TTL level signal. High when PSU turns on.

Between DC-OK(pin6) and DC-OK GND(pin2)	Output Status
3.3 ~ 5.6V	ON
0 ~ 1V	OFF

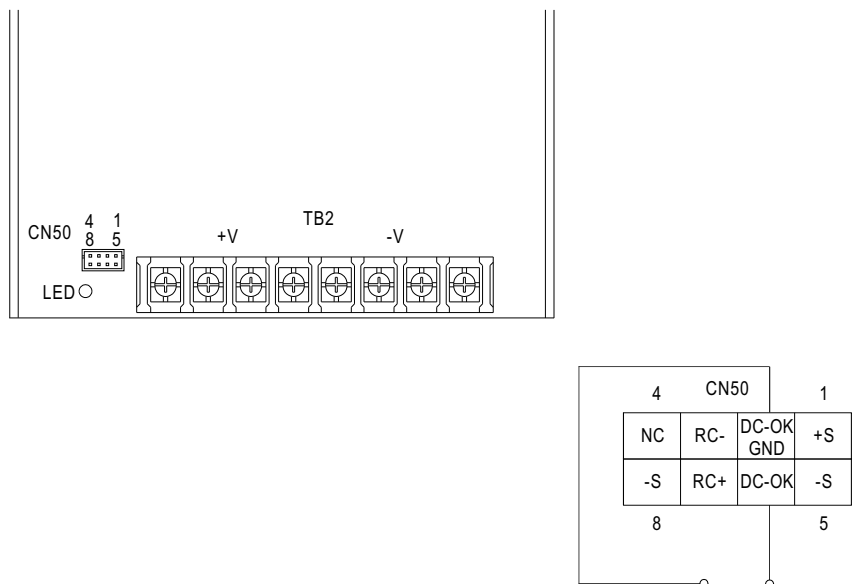

Fig 2.1

3.Remote Sense

The remote sensing compensates voltage drop on the load wiring up to 0.5V.

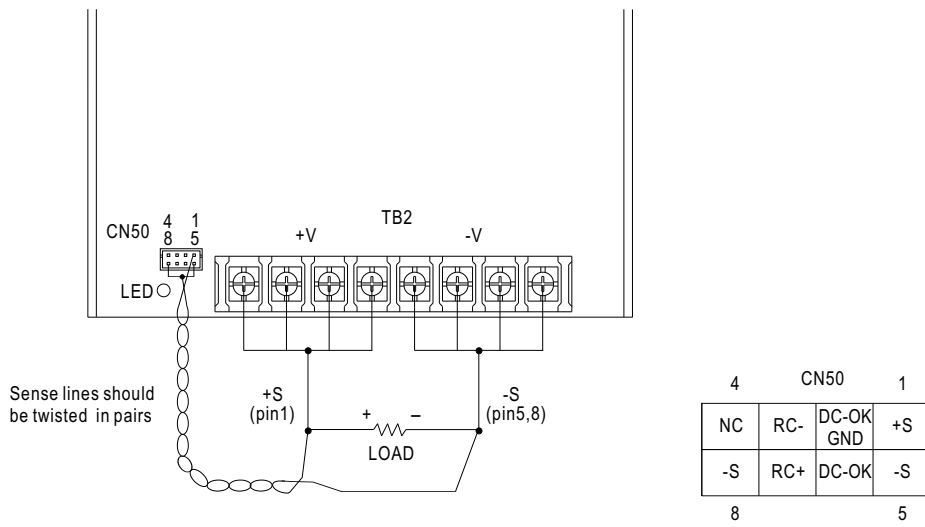

Fig 3.1