Power Supply and Battery Charger

MT Range

24Vdc

Three Phase Input

Instruction Manual

Overview

Preface

The “MT” series are a range of intelligent high-frequency power supply modules using switched mode technology. They are specially developed to meet the demands of modern DC systems. The charger rectifiers are designed with world leading and patented technology under the category “resonant voltage type soft switching power supply technology”. They are highly efficient and stable, with simple to use yet intelligent control, and for their power they are physically small and light weight.

There are a number of different output ranges available, all of which have a large adjustment range, with the 24Vdc series being highlighted in this manual. The RS-485 interface, makes the modules easy to integrate within automated control systems such as substations, power plants, hydraulic systems, oil and gas installations and other DC power supply applications.

The latest generation modules have LED displays and rugged metal front panels

Main Characteristics

- Modular design allows for N+1 and redundancy
- LED voltage display
- RS-485 communication interface, for remote control and monitoring functions
- High efficiency, up to 95%-96%;
- Light weight and compact
- High power factor of $>.94$ due to full bridge rectifying circuit and active PFC
- Current share for parallel connection $<+/-3\%$, ensures that up to twenty modules can operate in parallel.
- Protection against reverse polarity connection
- LED indication for Run, Fault and Over Temperature

- **Output overvoltage protection**

If the output voltage is higher than the overvoltage protection threshold, the module will shut down automatically and the fault indication light will illuminate. The module will automatically stop supplying DC, but will not affect the normal operation of the system. The overvoltage protection threshold is set in the factory at:

- $31V \pm 5\%$ for 24V series,

- **Output current limiting protect**

The maximum output current is limited to 105% of the rated output current.

- **Output short-circuit protection**

If the module short circuits, the output voltage drops to 0 immediately. If there is a short circuit or a low battery voltage, the output current is 15% of rated current. The module will not be damaged under short circuit state, and will restart automatically after debugging.

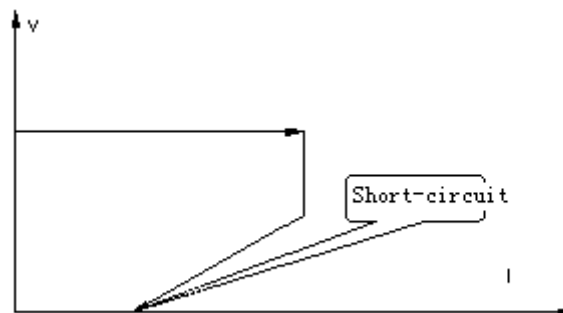

Fig.1-1 Output Characteristic

- **Module parallel protection**

There is a parallel protection circuit in each module to ensure that if a fault occurs within a module, the system won't be affected.

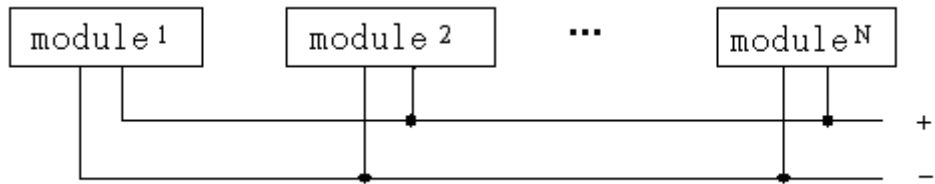

Fig.1-2 output of module parallel

- **Over-temperature protection:** When the temperature of the heatsink is over the 85°C threshold, the charger module shuts down automatically to protect itself and will restart once the temperature lowers.

- **Output over-current protection**

If overloaded, the output voltage decreases automatically to protect the power supply components. The over current protection can be resumed automatically.

Part Number Notation

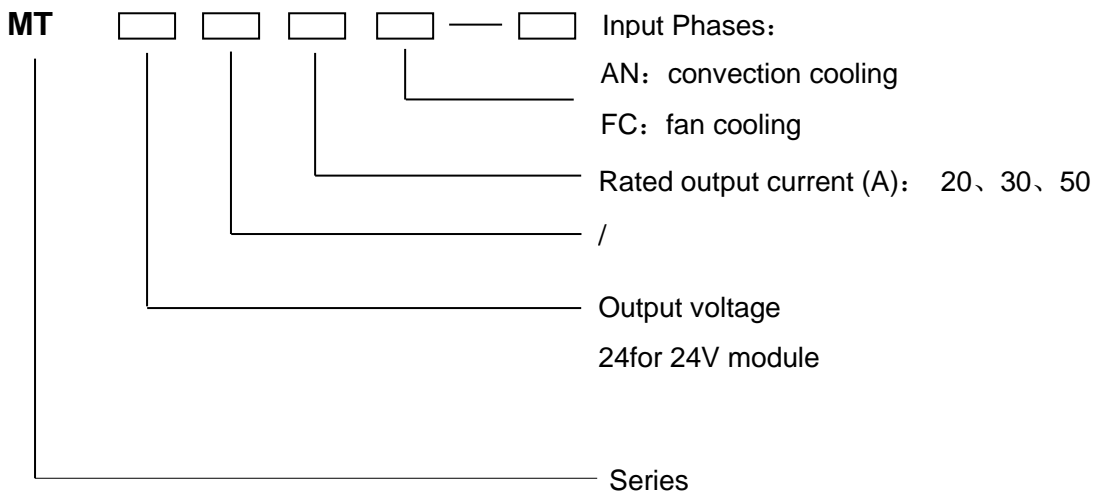

Main Features:

Parameter		Model	MT24/30A-AN3	MT24/50A-AN3
		Input	Input voltage	380V AC±15%, 3 phase
AC input frequency	45Hz ~ 65Hz			
Efficiency	≥95%			
Output	Output voltage	21-29V		
	Output current	30A	50 A	
	power (W)	900	1500	
	Start delay	3 ~ 8s		
	Ripple	≤ 20mV		
	Current stabilization	≤ 0.5%		
	Voltage stabilization	≤ ± 0.5%		
	Rectifier modules connected in parallel	Modules can be connected for parallel operation to increase current whilst maintaining a constant 24Vdc. Current sharing balance for modules in parallel ≤ ± 3%		
Cooling method		Natural cooling with heat sink		
Protocol MODBUS and CDT		RS485 or RS232 interface		
Audible noise		<50dB		
Protection	Multi-protection	Multi-protection and Warnings, including input over or under-voltage, output over or under-voltage, over-temperature, reverse connection, phase failure, and short circuit protection. The rectifier will shut down without output, and will return to normal operation after the fault is cleared.		
	Automatic current limiting	The output current will not exceed the set point. The set point is user adjustable.		
Intelligent function-microprocessor control	manual control	(1) Display of output DC voltage and current, adjustment of output DC voltage and current, setting of parameters for output over or under-voltage, setting alarm for output over or under-voltage, setting of parameters for output over-current. (2) Intelligent battery management: setting of parameters for battery boost charge and float charge, automatic change between boost charge status and float charge status.		
Environment	Operation ambient temperature	-20°C ~ 50°C		
	Storage temperature	-40°C~ 60°C		
	Relative humidity	≤ 90%		
	Air pressure	70 ~ 106kPa		

Safety	Insulation resistance	I/O to chassis and input to output >10MΩ (Test voltage: 500Vdc)
	Dielectric strength	Impose 2000Vdc between I/O and the chassis after shorting the input and output for one minutes. No breakdown or flashover
Mechanical	Size (H x W x D) mm	139x263x391
	Weight	10kg

MT24/50A-AN3 OUTLOOK AND DIMENSION ARE AS SHOWN BELOW:

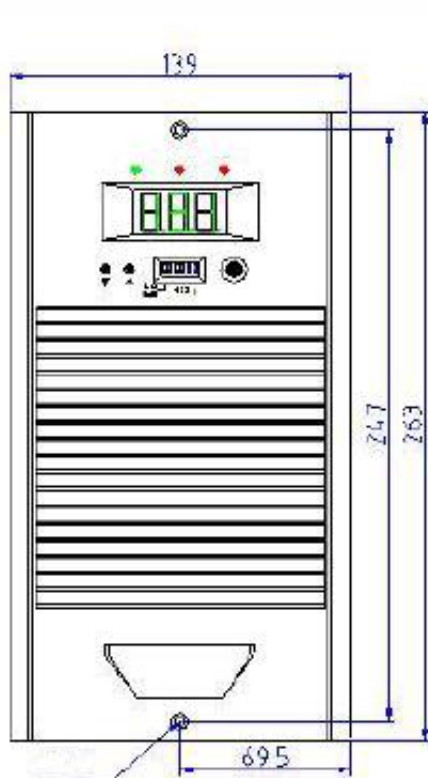

front view

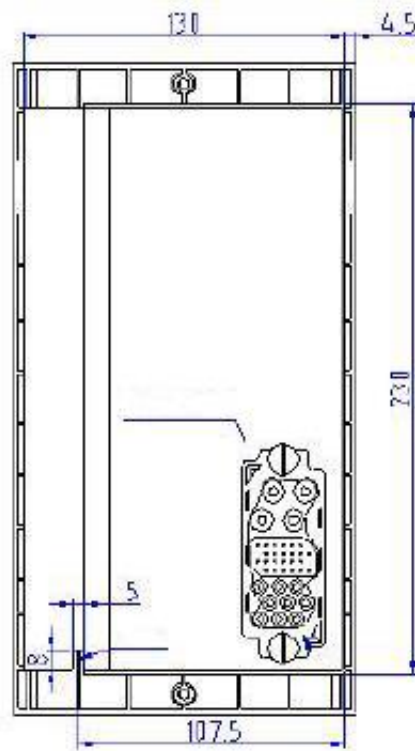

back view

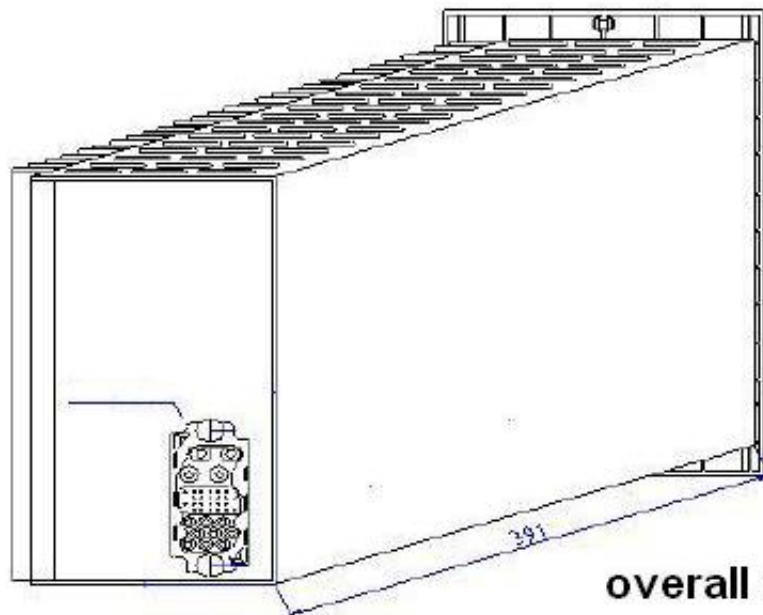

overall view

Installation of module

MT24V/50A-AN3

Definition is as follows

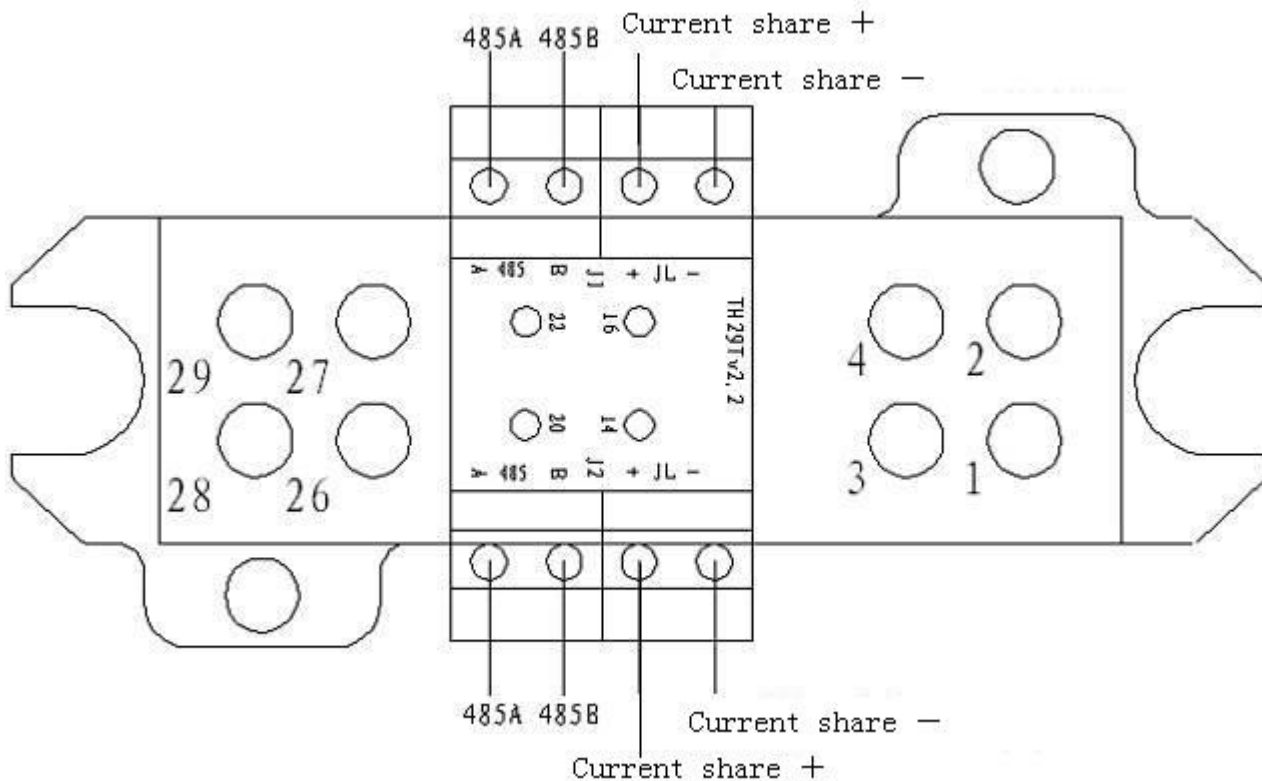

Pin No	Standard pins	definition	function
1、3	12#	DC+	DC output+
2、4	12#	DC-	DC output-
26	12#	G	EARTH
27	12#	A	Input380V
28	12#	B	Inptu380V
29	12#	C	Input 380V

- ① Undefined ports are empty
- ② Ensure the module is ventilated when in use
- ② Ensure the fan cooled modules are well ventilated
- ③ Connect according to the indication “current share +”, “current share -” to achieve the automatic current share.
- ④ Wire terminal A and terminal B separately and connect with the host monitor through terminal A & terminal B of RS485 A, which achieve communication between the module and monitor

Operation Introduction

DIP Operation Instruction

There are two options available, **Information Inquiry** and **Parameter Set**, choose via the “**Auto**”&”**Manual**” DIP Switch. To change the settings, push the 1st DIP switch into position 0. You will now be able to see the values of the selected parameter. You can adjust these parameters, and they are set by pushing the 1st DIP switch to position 1.

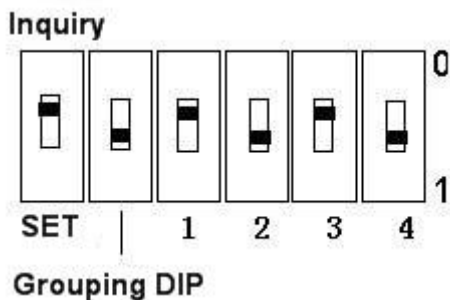

1. Information Inquiry:

When the furthest left DIP switch is in position 0, the following functions are available:

- 1, The LED screen can indicate the voltage, current and any fault information
- 2, Users can define the charger address via the grouping and address DIP switches

- LED screen

This screen indicates the voltage, current, and any alarms of the charger. Users can switch between these with the **V/A** button

Table 1 Fault code and identification

Code	E01	E02	E04	E05	E06	E20
Identification	Under voltage	Over voltage	Over voltage/current protection	Over temperature	Input fault	Setting over range

- Grouping DIP switch

The second DIP switch from the left is the grouping DIP switch (broadcast address identification code) and is used for identifying packet groups (Broadcasting Data packet.)

For ZTM protocol. If the switch is in position 0, the charger is in packet group 1 and the broadcast data packets are 253 and 255. If the switch is in position 1, the charger is in packet group 2 and the broadcast data packets 254 and 255.

For MODBUS protocol: If the switch is in position 0, the charger is in packet group 1 and the broadcast data packet is 255. If the switch is in position 1, the charger is in packet group 2 and the broadcast data packet is 254.

- Address set DIP

The right 4 communication addresses are set by the DIP switch and the broadcast address identification code is composed of the communication address. The DIP switch is also used for setting the communication address of the module. The address is a binary code. Each DIP correlates to a number, and if the DIP is on the top it means 0 and 1 if at the bottom. The rightmost code among is the lowest digit and the leftmost code is the highest digit. The address DIP of power supply module are 5 digits, so the set range of communication address is 0~31. That is to say, maximally 32 modules could be connected to one serial port of the host controller. The address is the only sign the controller could identify each module and the address of each module must be different in one system. For one module, the communication address setting must be same as the address setting of the host controller module. Otherwise abnormal communication occurs. The address in controller is decimal digit and the relation table is as follows.

Table 2 relation between binary and decimal digit

Binary	00000	00001	00010	00011	00100	00101	00110	00111	01000	01001	01010	01010	01100	01101	01110	01111
Decimal	0	1	2	3	4	5	6	7	8	9	10	11	12	13	14	15
Binary	10000	10001	10010	10011	10100	10101	10110	10111	11000	11001	11010	11011	11100	11101	11110	11111
Decimal	16	17	18	19	20	21	22	23	24	25	26	27	28	29	30	31

For example: the DIP set above highlighted in black is binary digit 10101, corresponding decimal address is 21. This charger is in Group 2.

2. Parameter set

To set parameters, place the furthest left DIP switch in position 1. Use the Grouping DIP switch and the 4 right DIP switches to select the required function. The DIP switch codes and functions are as follows.

Table 3 DIP identification (24V)

DIP	Grouping DIP	1	2	3	4	Function	Setting range	Default	
	0	0	0	0	0	Working mode	0-IND., 1-MANU, 2-AUTO	2	
	0	0	0	0	1	Communication protocol	0-Modbus, 1-ZTM	1	
	0	0	0	1	0	Over voltage alarm set	24V	Under voltage threshold-29V	29V
	0	0	0	1	1		24V	Over voltage threshold – 21V	21V
	0	0	1	0	0	Charging state set		0-float charge, 1-boost charge	0
	0	0	1	0	1	Float charge voltage	24V	21-29V	27.6V
	0	0	1	1	0		Boost charge voltage set	24V	21-29V
	0	0	1	1	1	Charging current limit set		10%-105% rated current	105%
	0	1	0	0	0	Current threshold from float to boost charge	Current threshold from boost to float charge-105%	80%	
	0	1	0	0	1	Current threshold from boost to float charge	0.5-current threshold from float to boost	20%	
	0	1	0	1	0	Tail current charging time	0-10 hours	3	
	0	1	0	1	1	Max boost charge time	0-99 hours	10	
	0	1	1	0	0	Boost charge cycle	0-999 days	180	
	0	1	1	0	1	Fault output node set	0-normally open 1-normally close	0	

NOTE: you need to power on the charger again if you change the communication protocol on line

When the DIP setting is over the range in the table above, the display will indicate E20.

The setting operation instruction:

Settings can be configured by using the DIP Switches and the ▼,▲ buttons. To begin, the first DIP switch must be placed in position 1, and the required function code entered by using the remaining DIP switches. Press the 'V/A' button once and the display will flash. The value can now be adjusted using the ▼,▲ buttons. Press the V/A button once more to store the value.

The power supply has three working modes; Independent, Automatic and Manual. There are also two communication protocols available, ZTM and MODBUS. The RS485 interface is available between charger and controller or charger and charger.

Independent "IND.": the charger will work independently when set to working mode "0". The DIP switch position will be "00000". Then the communication protocol "00001"- "1" ("TH" protocol) will be advised. Under this working mode, the charger cannot communicate with the master controller, but automatic float and boost charge is available. The charger can manage the charging process automatically. It is also capable of sending charging voltage and current commands to control other chargers if several chargers work in parallel.

This mode is suitable for use without a master controller and several chargers working in parallel. One charger will be "IND" mode as master module to send commands to other chargers. The other chargers will be set to "AUTO" mode and "ZTM" protocol.

Manual "MANU": To set the charger to Manual mode set working mode as "00000" -"1". Communication protocol is set to "ZTM" when the DIP is set to "00001"- "1". It is "MODBUS" when set "00001"- "0". The user can set accordingly with the upper controller. Under this working mode, the charger can communicate with the controller and send data back to the controller. Automatic float and boost charge function is available but the charger cannot send commands to other chargers.

This mode is suitable when the additional controller does not have automatic float and boost charge function but the controller needs to know the working status of other chargers. This setting is suitable for a system containing one charger and one battery bank.

Automatic "AUTO": corresponding DIP set is "00000" -"2". Communication protocol is set to "ZTM" when the DIP is set to "00001"- "1" It is "MODBUS" when set to "00001"- "0". When set to "AUTO" mode, the charger will work following the setting of the controller. In this mode, the module can be controlled remotely with four settings. These "four remotes" are remote

signaling, remote measure, remote control and remote regulating. The charging voltage and current are controlled by the master controller.

This mode is suitable for use with a master controller for automatic float and boost charge management function and can control the chargers remotely.

NOTE: When the charger is in “AUTO” mode, the output voltage will come to 234V/117V/48V/24V and the current limit threshold will be the maximum of 105% rated current, until a comms connection is reached. Pay attention to the RS485 A&B correspondingly when wiring.

Fault Display

In the event of a fault, a fault code will be displayed on the LED screen. Fault codes are shown in Table 4-3. The voltage can be shown by pushing the V/A button.

Table 4-3

Fault code	E01	E02	E03	E04	E05	E06
Definition	Output Under voltage	Output over voltage	Output Overflow protection	Output over voltage protection	Overheat protection	Ac input Abnormal

Communication Function

The module can communicate with an external DC Controller (the USV6H). It can send information such as the output voltage and current, alarm information and alarm information to a host controller. It can also accept and implement the control orders issued by the host controller. The USV6H is also compatible with PC software. Please contact your supplier for more information on the USV6H range.

Note: When the charging module is in automatic mode, if there is not any communication in 4 minutes, the output voltage will be adjusted to 24V automatically. Current limiting points will be set at 105% of rated current value.